

Scotsman® CME 656



- CME1656
- CME1356
- CME 656**
- CME 506
- CME 456
- CM450SL
- SCE 275



CME 656 with BH550

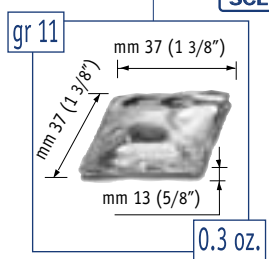

CONTOUR ICE

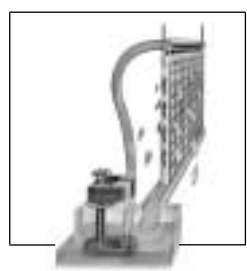







**Modular
Contour
Cube Ice
Machine**

**Machine
Modulaire
à Glaçon
Contour**

**Contour
Kombi
Eisbereiter**

**Máquina
Modulare
Fabricadora
de Cubitos
Contour**

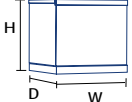
**Fabbricatore
Modulare
di Ghiaccio
Contour**

						
	[kg] [lbs] N°	[kg] [lbs]	[v/Hz/ph]	[HxWxD mm] [HxWxD inches]		
CME 656 AS	204 450 28.900	230 506	230/50/1	686x762x610 27" x 30" x 24"	R 404 a	
CME 656 WS	208 459 26.500	230 506	230/50/1	686x762x610 27" x 30" x 24"	R 404 a	

2

Years Warranty
Ans de Garantie
Jahre Garantie
Años de Garantía
Anni di Garanzia

Subject to certain limitations and exclusions
Assujettie aux limites et exclusions prescrites
Abhängig von Bestimmten Einschränkungen und Ausnahmen
Sujeta a ciertas limitaciones y exclusiones.
Soggetta ad alcune limitazioni ed esclusioni



This product qualifies for the following listings:

Models and specifications are subject to change without notice - Les modeles et les caracteristiques des appareils peuvent être changés sans préavis - Wir behalten das Recht vor jederzeit Änderungen der Modelle und der technischen Angaben vorzunehmen. Los modelos y las características pueden ser modificados en cualquier momento sin previo aviso - I modelli e le specifiche possono essere cambiate in qualunque momento senza preavviso

CME 656

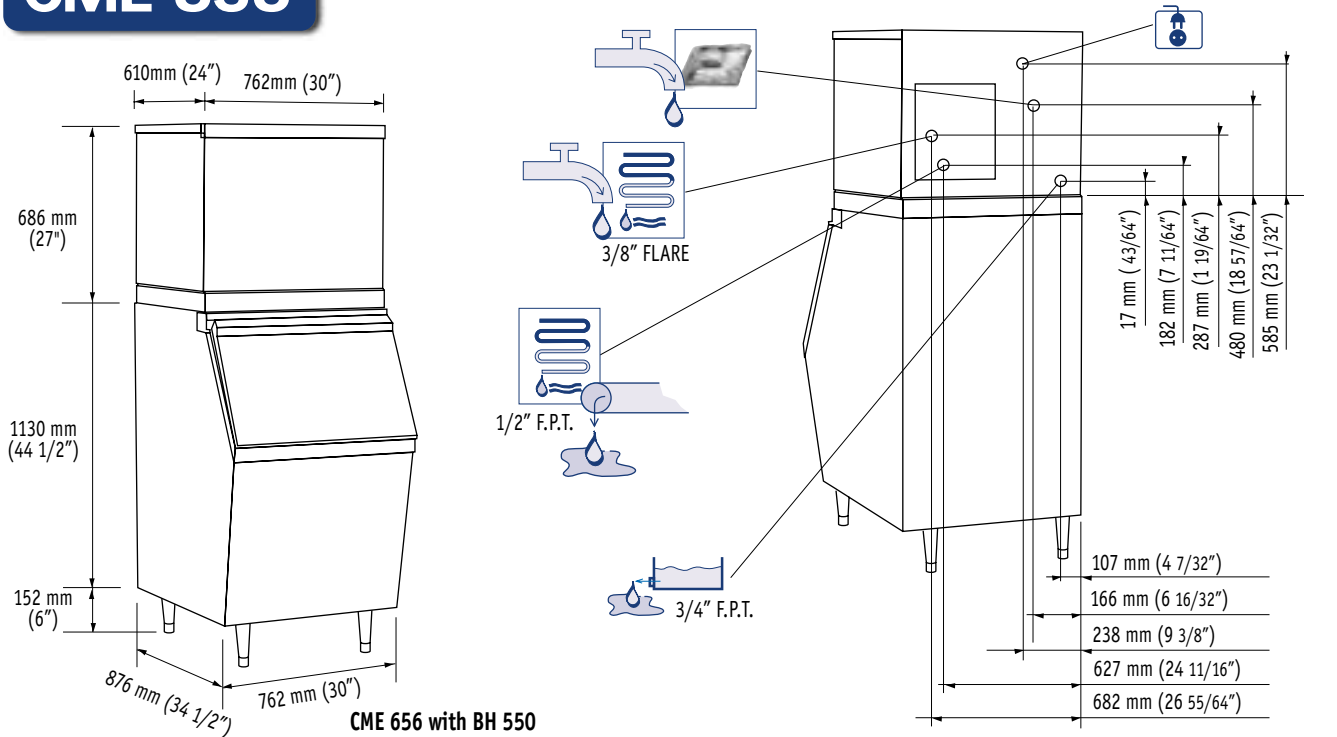

CME 656 with BH 550

	[Btu/h]	[W]	[Ømm ²]	[W]	FUSE	[kWh]	[L/h]	[gal/h]	[kg]	[lbs]	[kg]	[lbs]
CME 656 AS	8330	2440	3 x 1,5	2135	20 A	29.6	14	3.5	95	209	102	225
CME 656 WS	8330	2440	3 x 1,5	1402	20 A	27.3	135	36	95	209	102	225

CME 656 AIR



°F	90°	70°	60°	50°	
°C	32°	21°	15°	10°	
50°	-	-	-	-	lbs
10°	-	-	-	-	kg
70°	-	-	-	705	lbs
21°	-	-	-	320	kg
90°	-	583	-	-	lbs
32°	-	264	-	-	kg
100	-	-	-	-	lbs
38°	-	-	-	-	kg



CME 656 WATER



°F	90°	70°	60°	50°	
°C	32°	21°	15°	10°	
50°	-	-	-	-	lbs
10°	-	-	-	-	kg
70°	-	-	-	654	lbs
21°	-	-	-	293	kg
90°	-	575	-	-	lbs
32°	-	261	-	-	kg
100	-	-	-	-	lbs
38°	-	-	-	-	kg



Minimum

10°C (50°F)

5°C (41°F)

-10%

1 BAR
14 psi



Maximum

40°C (104°F)

35°C (95°F)

+10%

5 BAR
70 psi

Machine requires voltage indicated on rating name plate. Failures caused by improper voltage are not considered factory defects. Scotsman products are not designed for outdoor installation. Extended periods of operation at temperatures exceeding the above limitations constitutes misuse under the terms of Scotsman Limited Warranty, resulting in a loss.

La machine doit être raccordée conformément au voltage indiqué sur la plaque signalétique. Les éventuels dégâts causés par un non respect de cette consigne ne peuvent être considérés comme des défauts de fabrication. Les machines à glace Scotsman ne sont pas conçues pour être utilisées à l'extérieur. Le fonctionnement prolongé à des températures supérieures ou inférieures aux limites ci-dessus sont considérées comme une mauvaise utilisation dans le cadre de la garantie Scotsman.

Der Eisbereiter benötigt eine Stromspannung gemäß Geräte-Typenschild. Störungen oder Ausfälle, durch den Betrieb mit falscher Stromspannung sind keine Fabrikationsfehler und fallen nicht unter Garantie. Scotsman Eisbereiter sind nicht für die Installation im Freien geeignet. Der längere Betrieb bei Temperaturen über den obigen Grenzwerten ist eine falsche Anwendung und bedeutet den Verlust der Garantieleristung.

Los requerimientos eléctricos de la máquina estan indicados en la placa de características. Los daños causados por voltajes inadecuados no son considerados defectos de fábrica. La máquinas de hielo Scotsman, no estan diseñadas para trabajar a la intemperie. Largos periodos de funcionamiento a temperaturas que excedan de las limitaciones indicadas, constituyen maltrato de acuerdo con las observaciones de Scotsman.

La macchina richiede il voltaggio indicato sulla targhetta di identificazione. Danni causati da voltaggi diversi non sono considerati difetti di produzione. I prodotti Scotsman non vanno utilizzati all'aperto. Un prolungato periodo di utilizzo al di fuori delle temperature indicate non è consentito e causa l'automatico decadere della garanzia.



Scotsman® The one the world relies on.
Ice Systems

USA, Canada, Central and South America
Scotsman Ice Systems USA
775 Corporate Woods Parkway
Vernon Hills, IL 60061
Ph: (847) 215-4550 - Fax (847) 913-9844
E-Mail: customer.service@scotsman-ice.com

Europe, Middle East and Africa
Scotsman Europe - Frimont S.p.A.
Via Puccini, 22
20010 Bettolino di Pogliano (Milano) Italy
Ph: (+39) 02-93960208 - Fax: (+39) 02-93960201
E-Mail: scotsman.europe@frimont.inet.it

Asia and Pacific
Scotsman Ice Systems-Frimont S.p.A. (R.O.)
321 Orchard Road #08-05
Singapore 238866
Ph: (+65) 738 5393 - Fax: (+65) 738 1959
E-mail: scotsice@singnet.com.sg

China
Scotsman Ice Systems
258 Tong Ren Road Golden Tower 7A
Shanghai - 200040 Peoples's Republic of China
Ph: (+86) 21-62476056-Fax: (+86) 21-62476126
E-mail: scotsmansh@online.sh.cn

